

	pas- en arm sluitzijde arm	Blad: 02
maten in mm	38/39mm dik buitendraaiend	
sept. 2013		

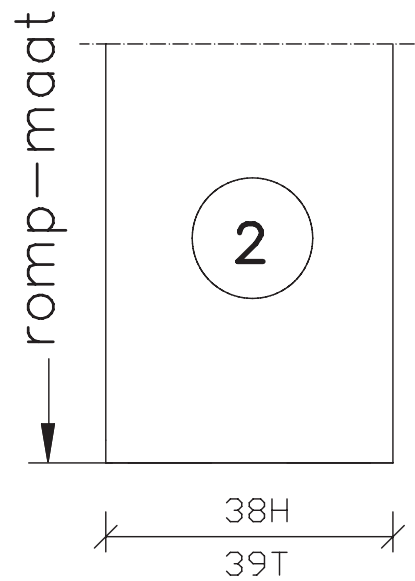

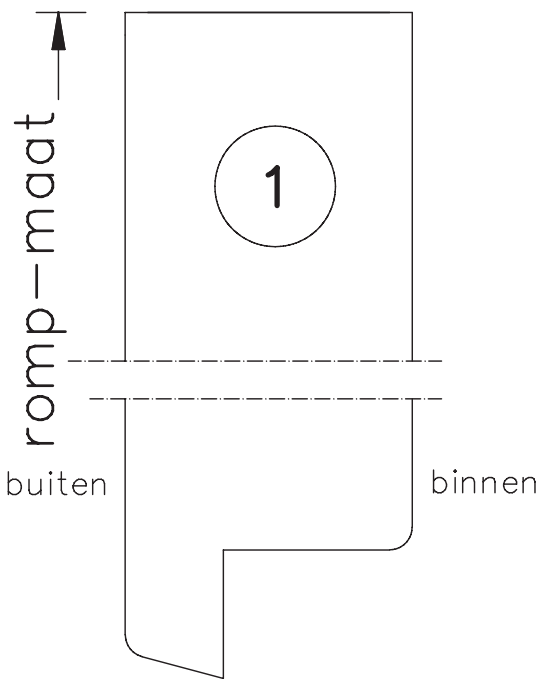

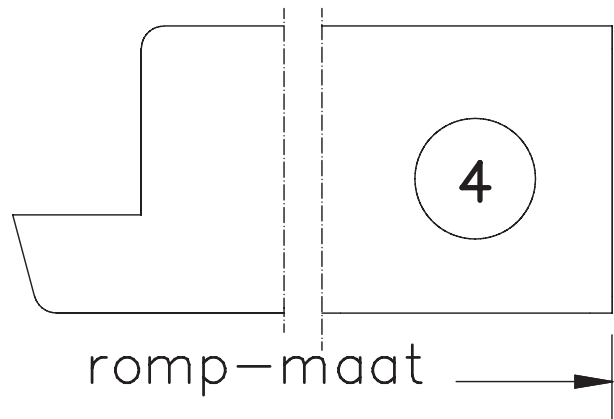
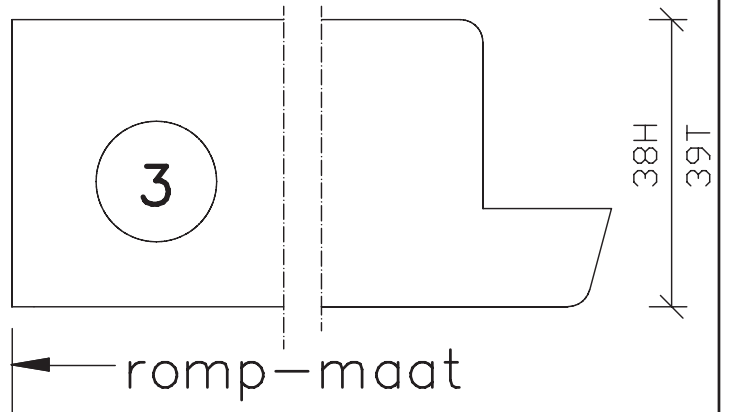
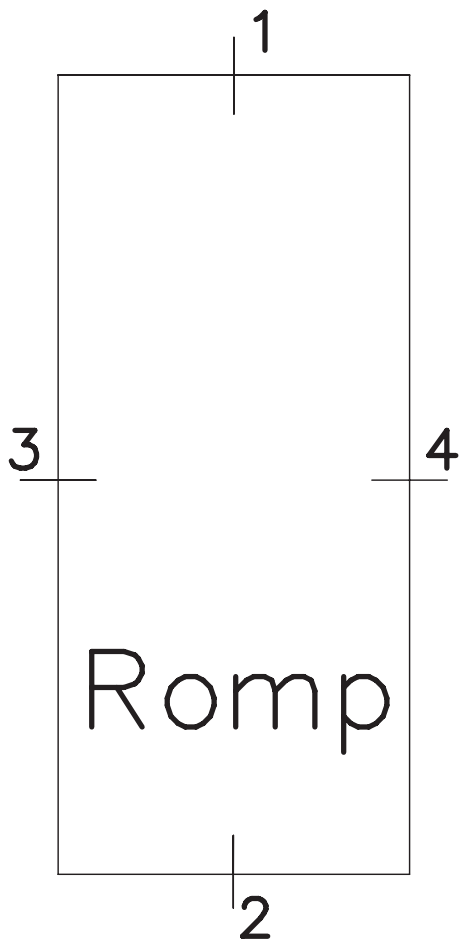
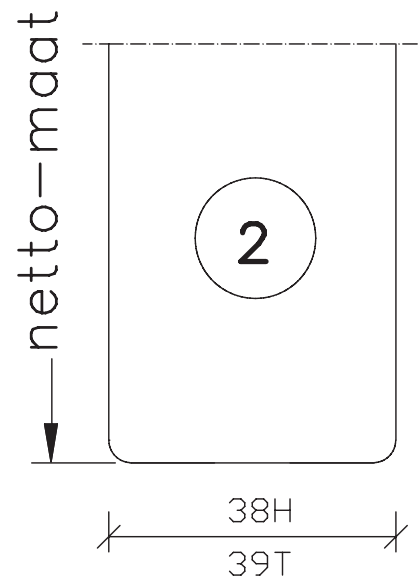
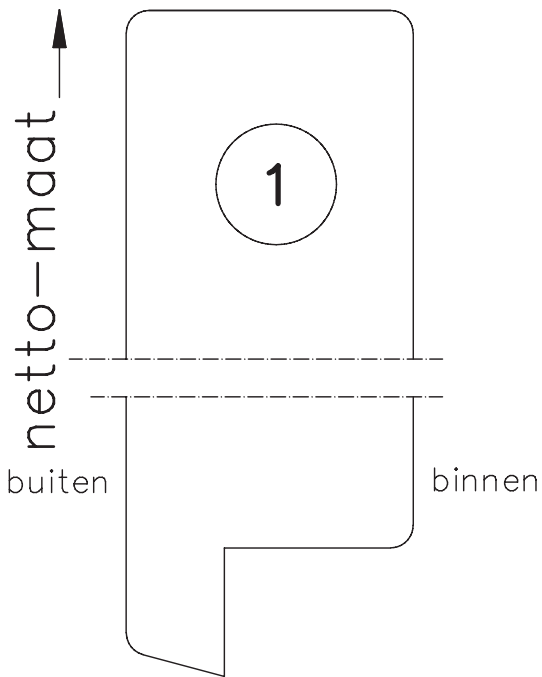
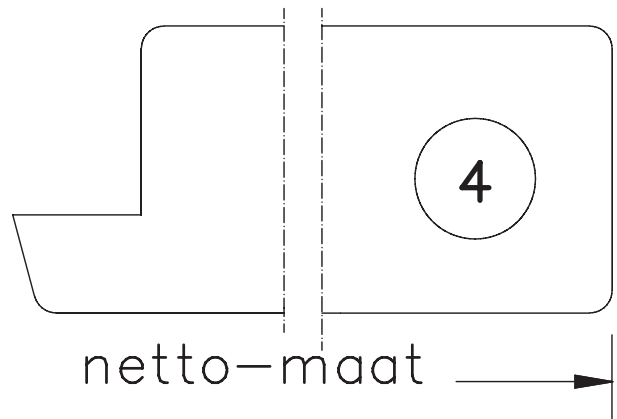
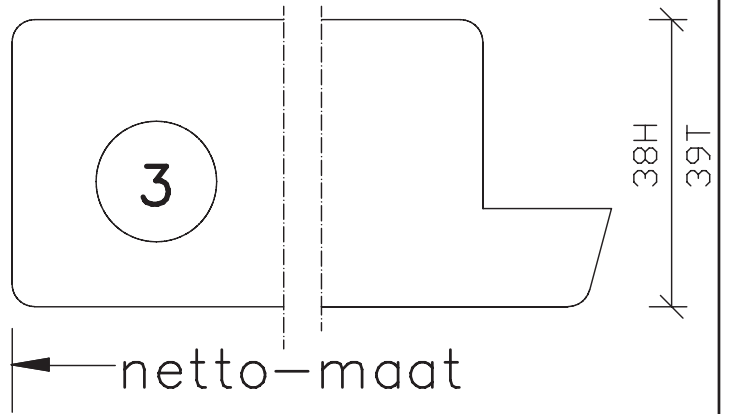
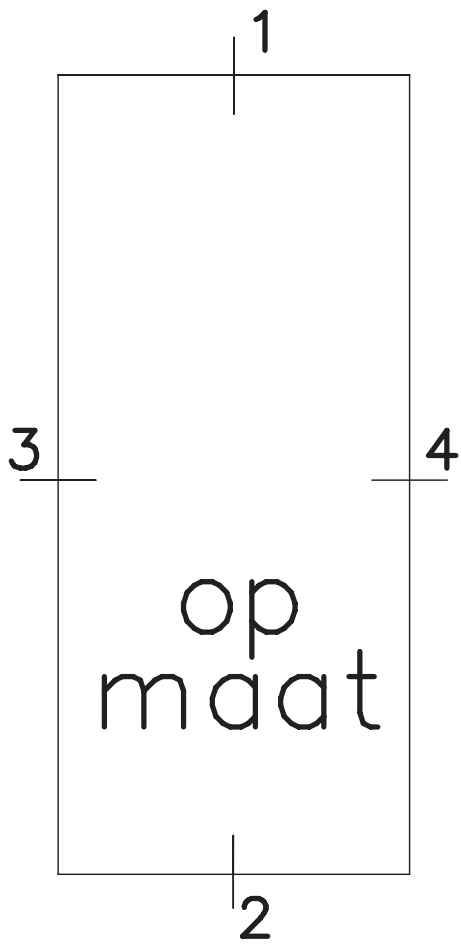
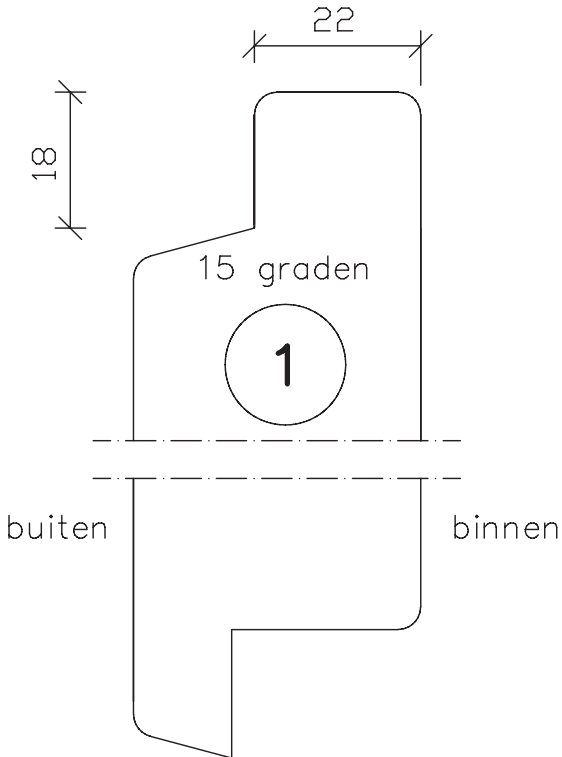
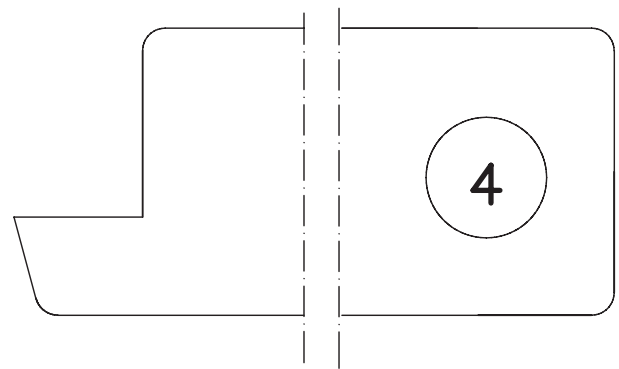
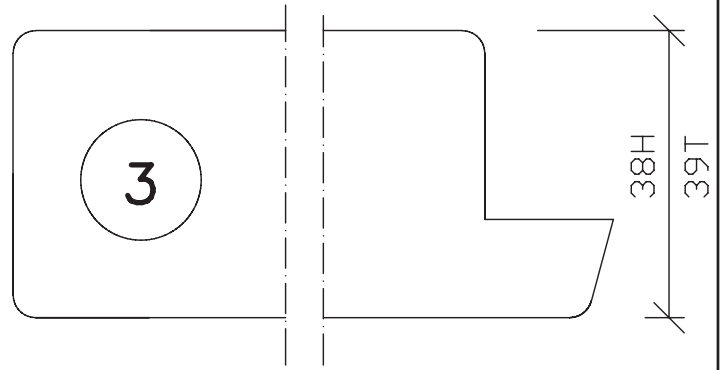
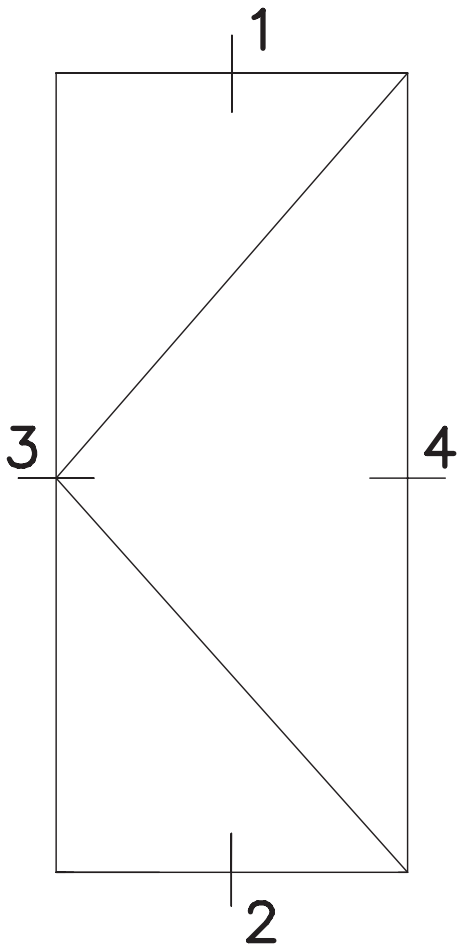

buiten



binnen



maten
in mm

mei
2006

verjonging
bovenzijde
deur

38/39mm dik
buitendraaiend

Blad:
21

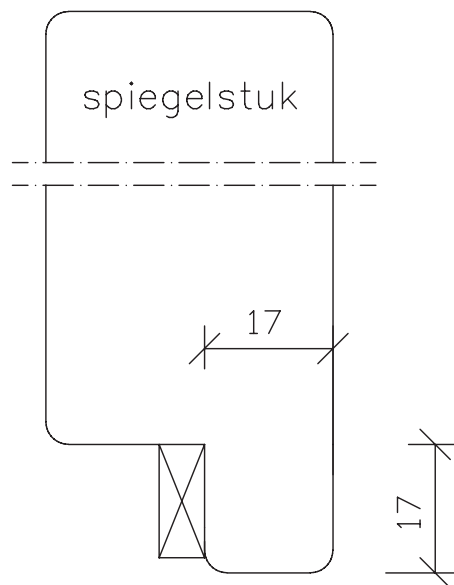

tussenruimte 2mm

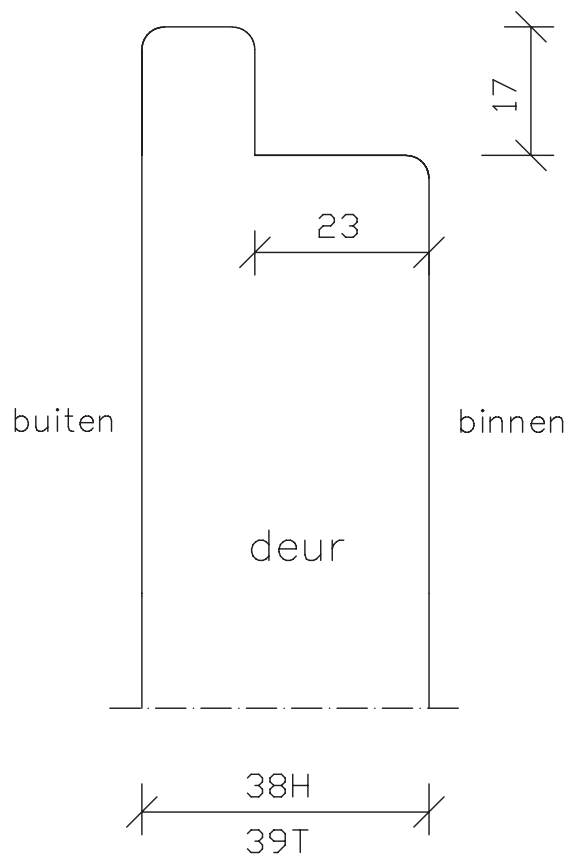

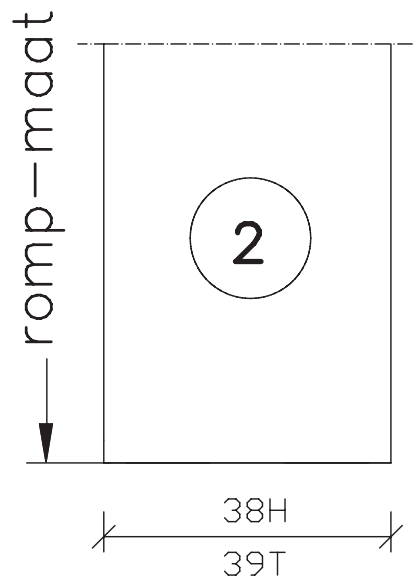
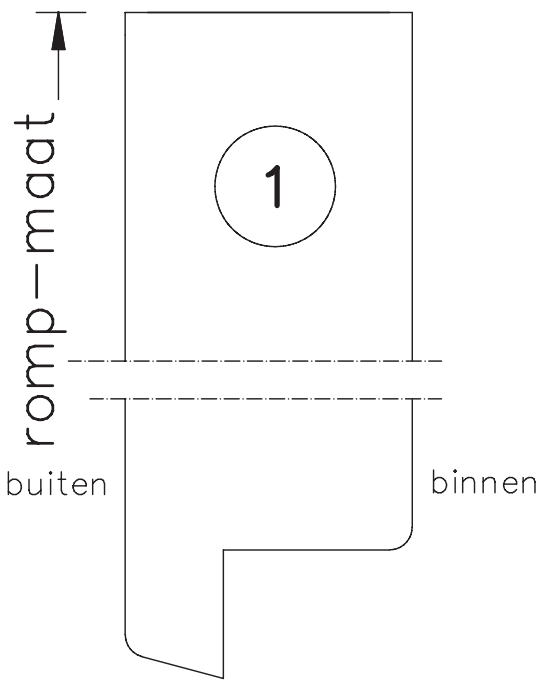
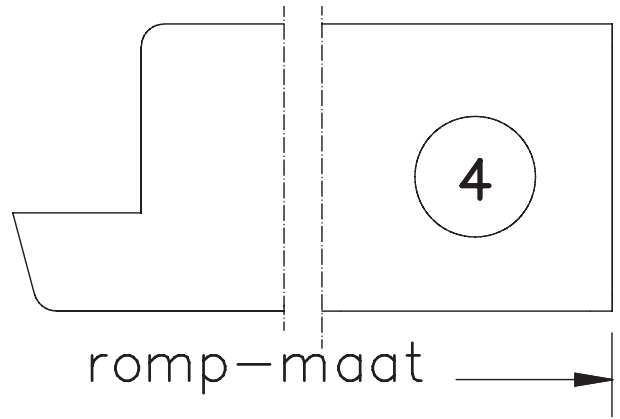
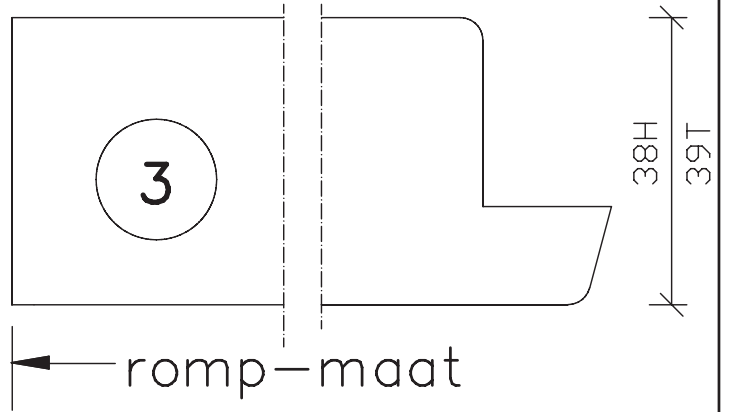
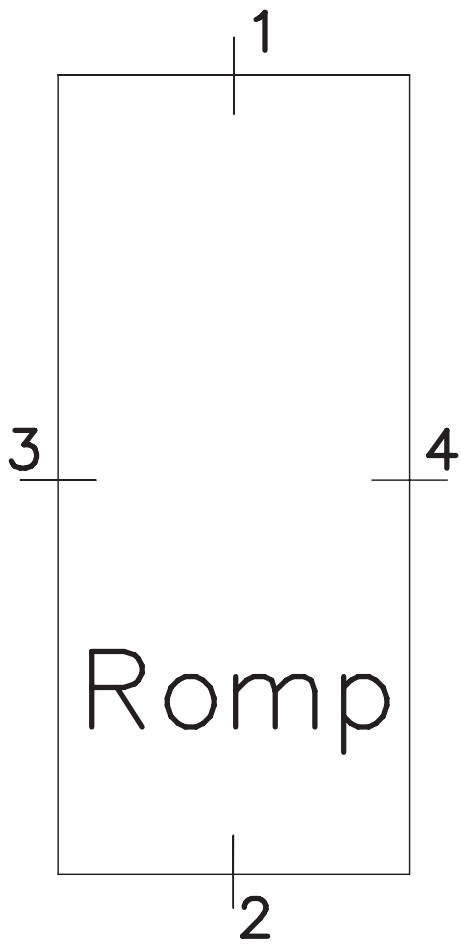

maten
in mm
sept.
2013

Romp
38/39mm dik
binnen en/of
buitendraaiend

Blad:
05

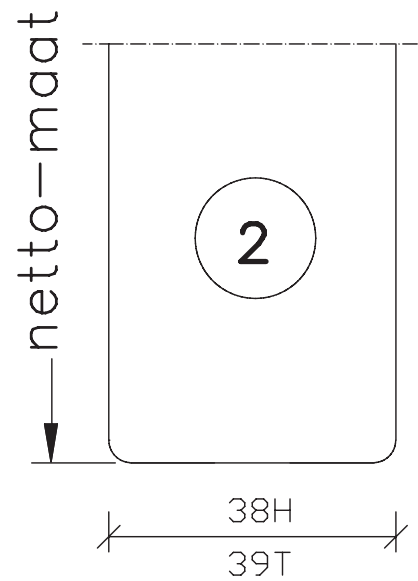
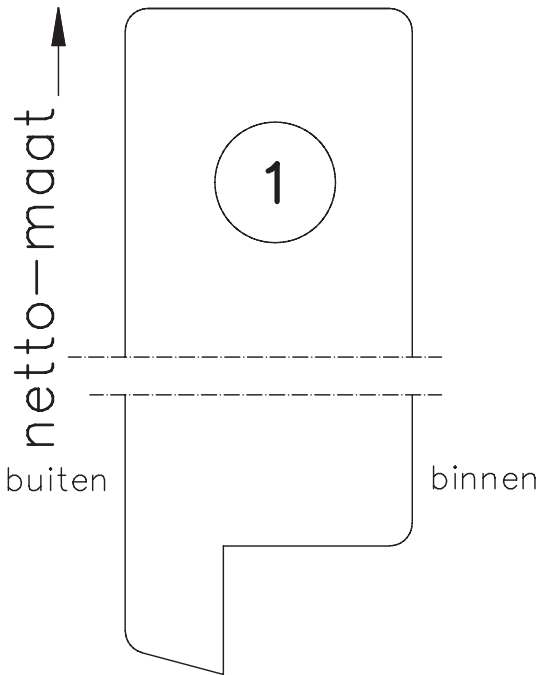
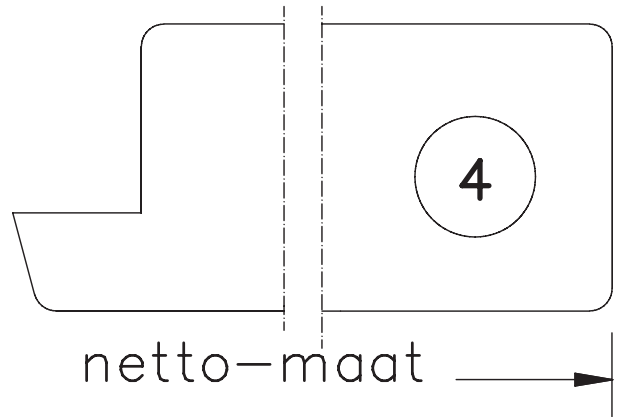
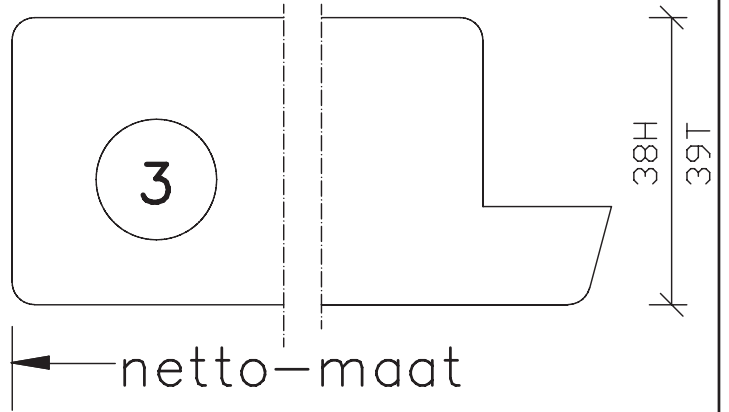
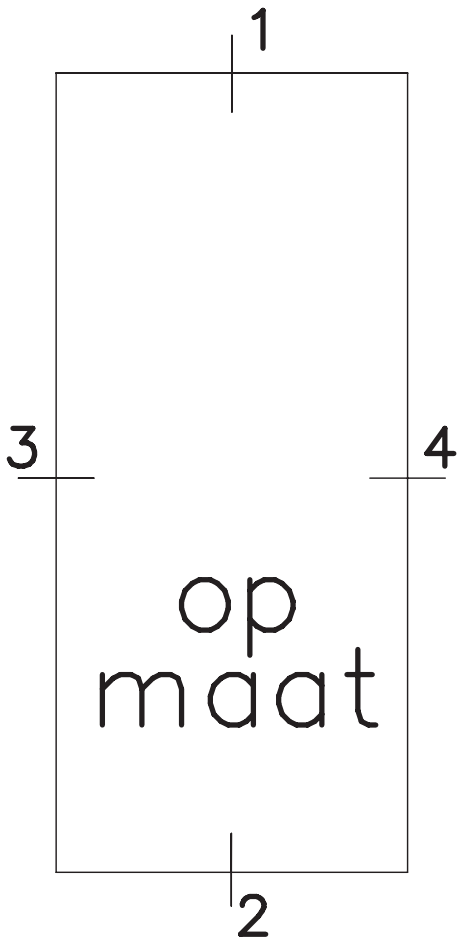

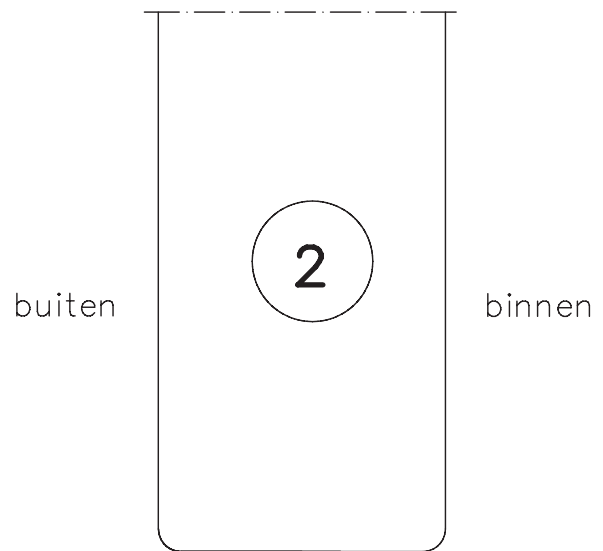
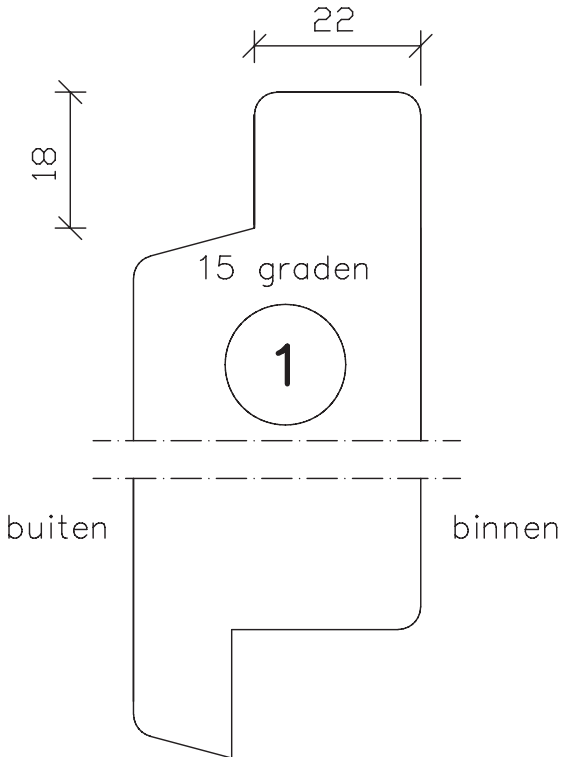
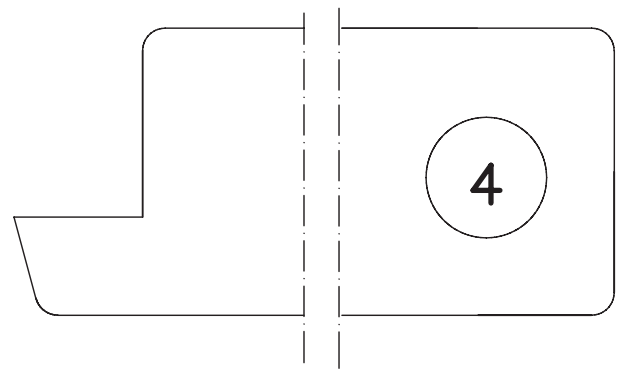
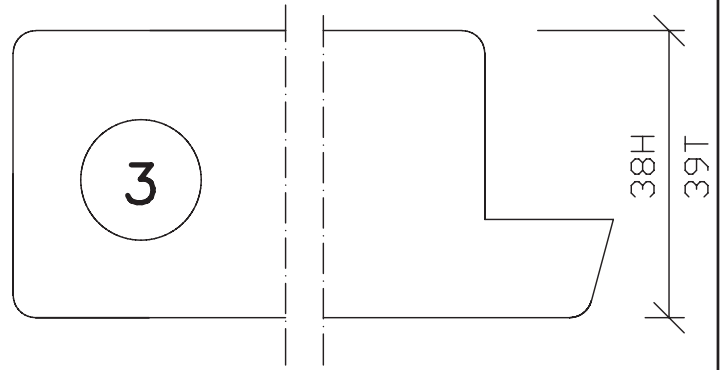
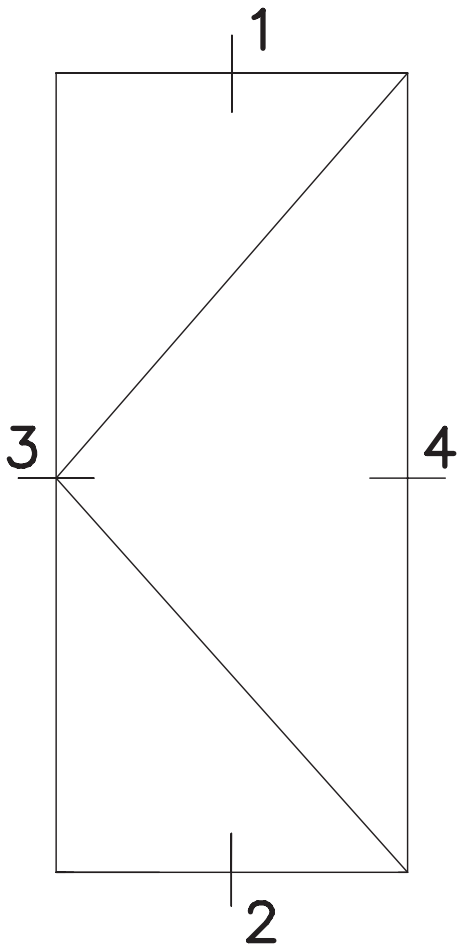

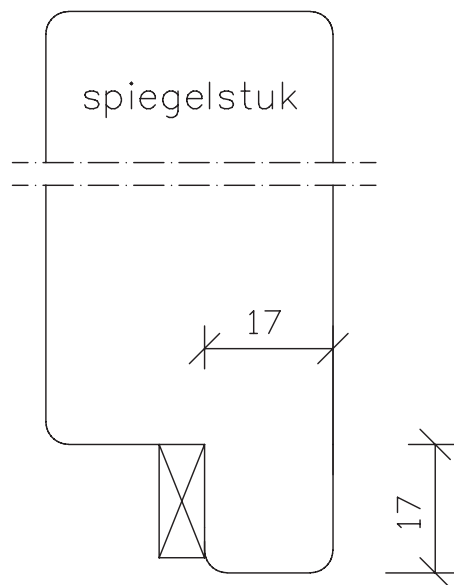

tussenruimte 2mm

